

**11.1.2 Software-Update**  
**B175R**  
**B260R**  
**B400R/RM/RH**

## 1) Flash SD-Card

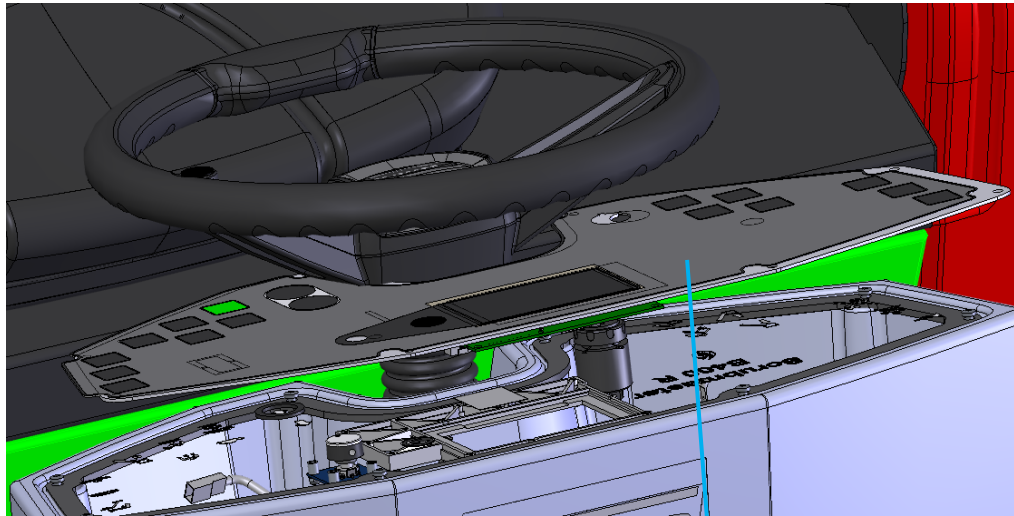

The SD cardslot is on the rear side of the display board A2. For flashing, the SD card has to be extracted from the slot. To do this dismount the dash-board (8 screws). Then you could take out the card.

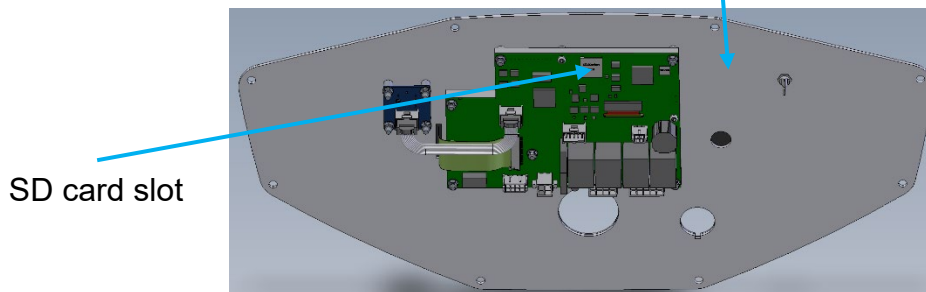

SD card slot

Rear side of dash board

## SD-Card into computer SD-Slot

Only one SD drive may be connected, otherwise an error message will appear.

The Hako Diagnosis must be connected to an interface. A connection to the machine is not necessary.

*Depending on whether not connected or connected follow the steps  
Interface is not connected to the machine      or  
Interface is connected to machine*

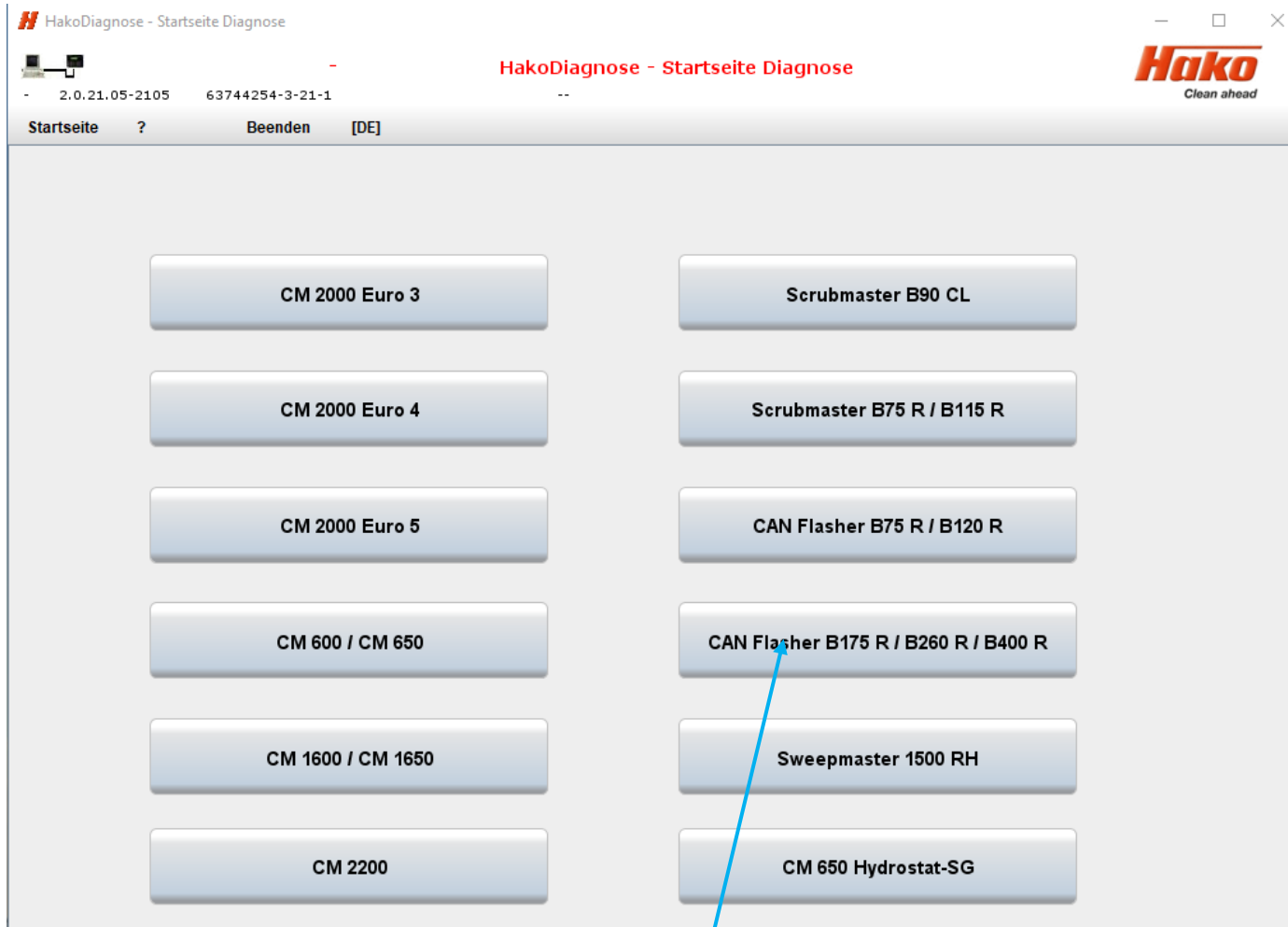

Choose "CAN Flasher B175R / B260R / B400R" program in Hako Diagnosis.

a) Interface is not connected to machine

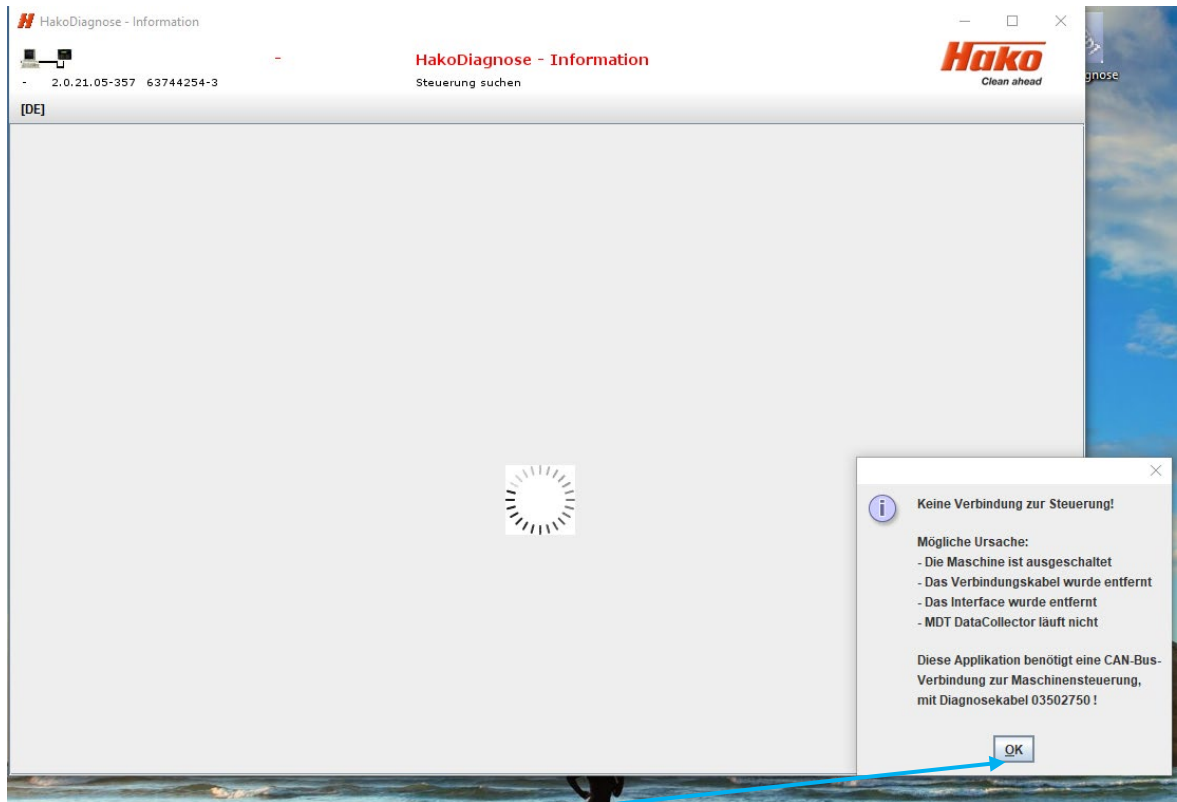

By choosing "OK" the search process is canceled.

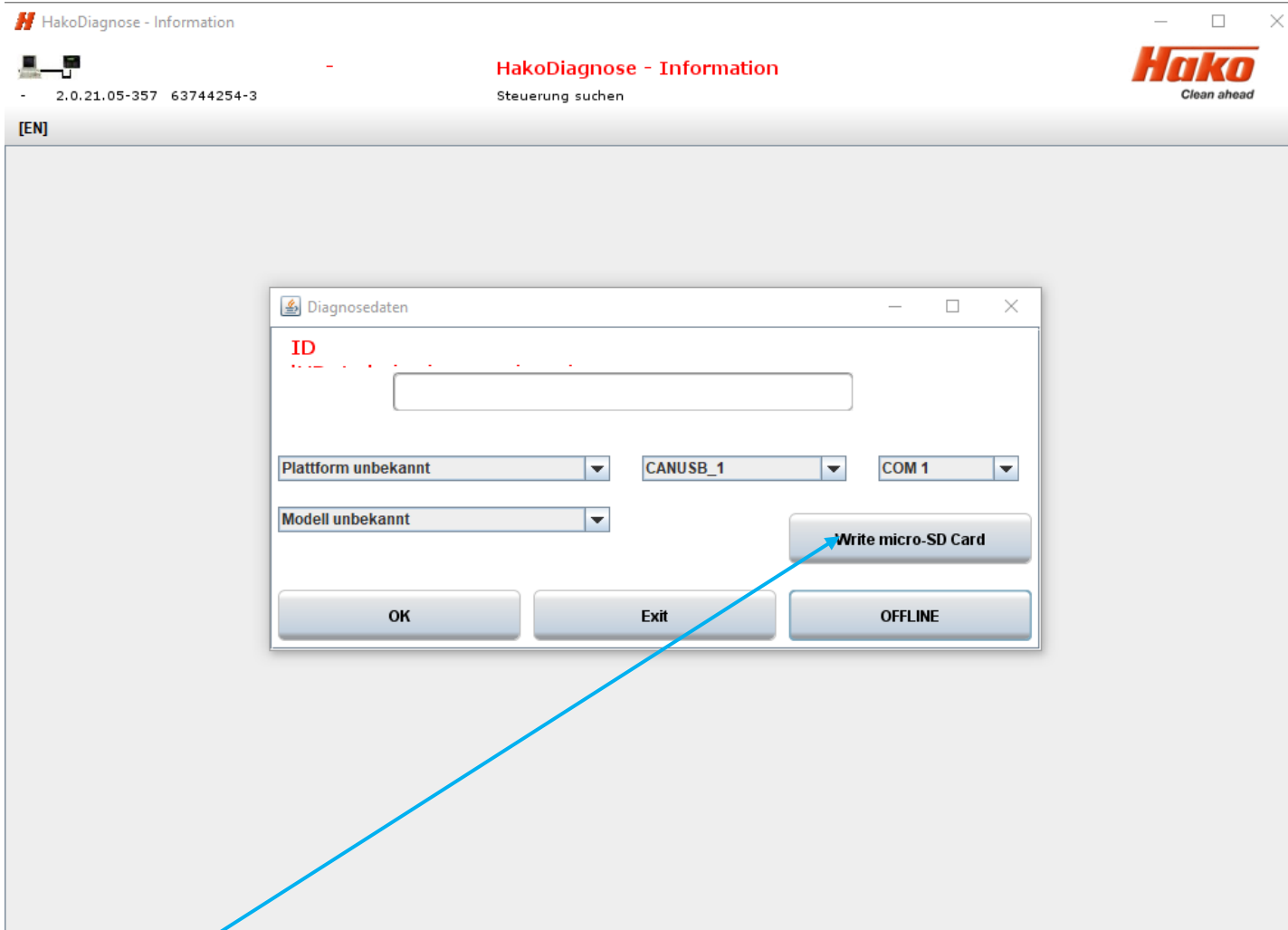

Choose "Write micro SD Card" program.

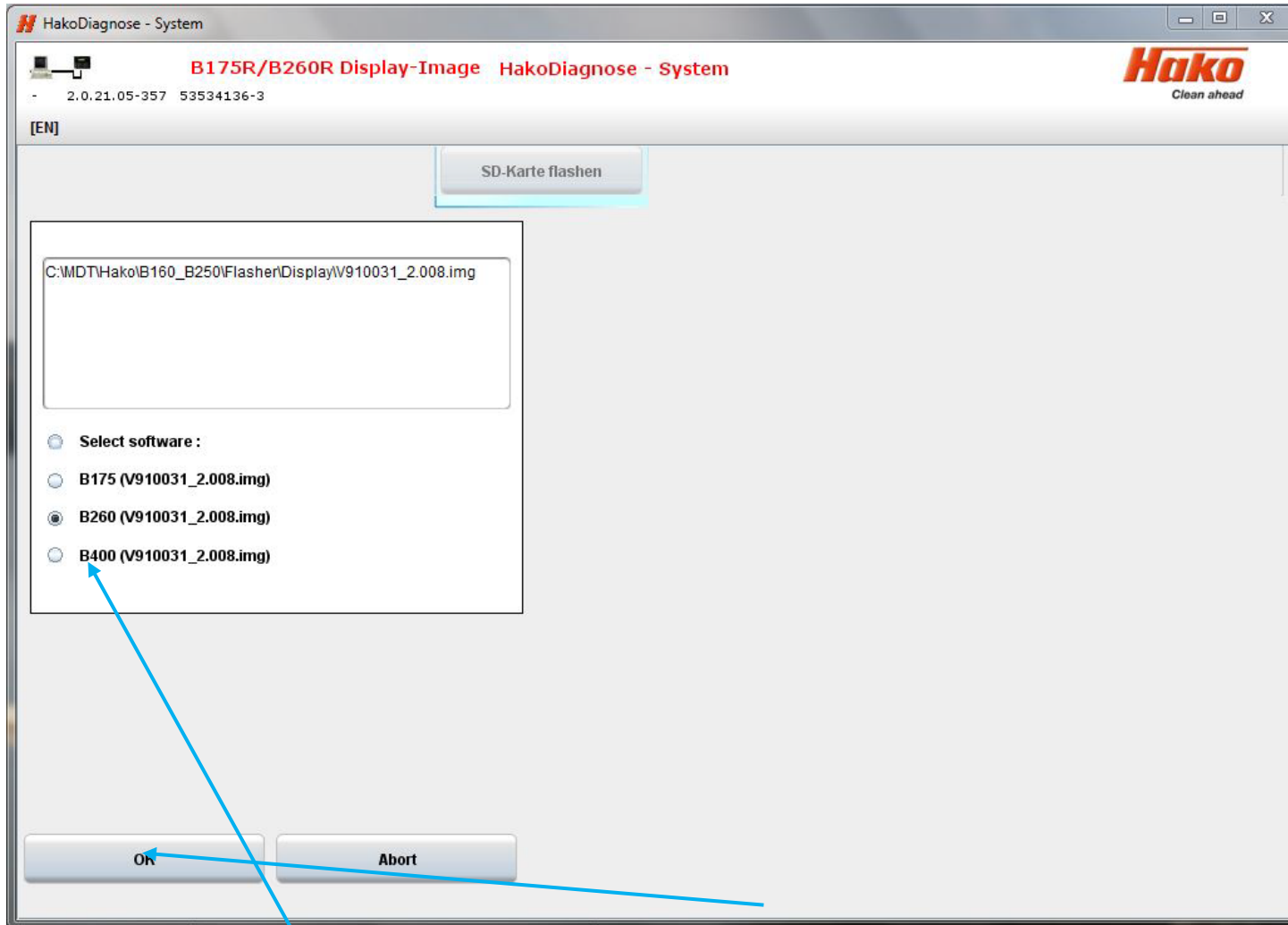

Choose corresponding machine and start flashing with "OK".

*\* The software versions shown here may differ, as the document is only a snapshot*

b) Interface is connected to machine (sample B260R, equal for all types)

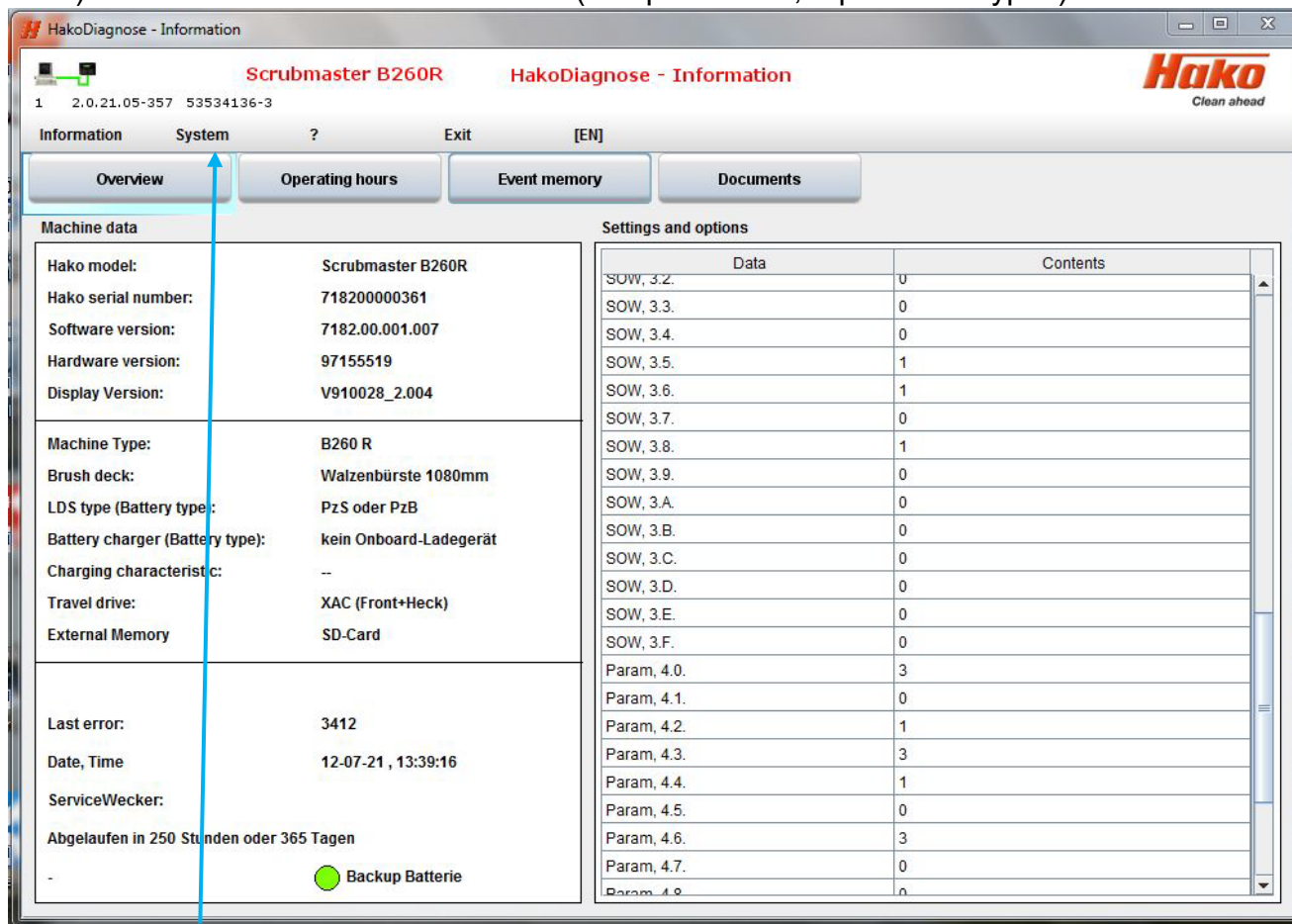

The screenshot shows the HakoDiagnose - Information software interface. At the top, it displays 'Scrubmaster B260R' and 'HakoDiagnose - Information'. Below the title bar, there are navigation buttons: 'Information', 'System', '?', and 'Exit [EN]'. A secondary row of buttons includes 'Overview', 'Operating hours', 'Event memory', and 'Documents'. The main content area is divided into two sections: 'Machine data' and 'Settings and options'.

**Machine data:**

- Hako model: Scrubmaster B260R
- Hako serial number: 71820000361
- Software version: 7182.00.001.007
- Hardware version: 97155519
- Display Version: V910028\_2.004

**Machine Type:** B260 R

- Brush deck: Walzenbürste 1080mm
- LDS type (Battery type): PzS oder PzB
- Battery charger (Battery type): kein Onboard-Ladegerät
- Charging characteristic: --
- Travel drive: XAC (Front+Heck)
- External Memory: SD-Card

**Last error:** 3412

**Date, Time:** 12-07-21, 13:39:16

**ServiceWecker:** Abgelaufen in 250 Stunden oder 365 Tagen

**Backup Batterie:** (indicated by a green circle icon)

**Settings and options:**

Data	Contents
SOW, 3.2.	0
SOW, 3.3.	0
SOW, 3.4.	0
SOW, 3.5.	1
SOW, 3.6.	1
SOW, 3.7.	0
SOW, 3.8.	1
SOW, 3.9.	0
SOW, 3.A.	0
SOW, 3.B.	0
SOW, 3.C.	0
SOW, 3.D.	0
SOW, 3.E.	0
SOW, 3.F.	0
Param, 4.0.	3
Param, 4.1.	0
Param, 4.2.	1
Param, 4.3.	3
Param, 4.4.	1
Param, 4.5.	0
Param, 4.6.	3
Param, 4.7.	0
Param, 4.8.	0

Choose menu "System"

\* The software versions shown here may differ, as the document is only a snapshot



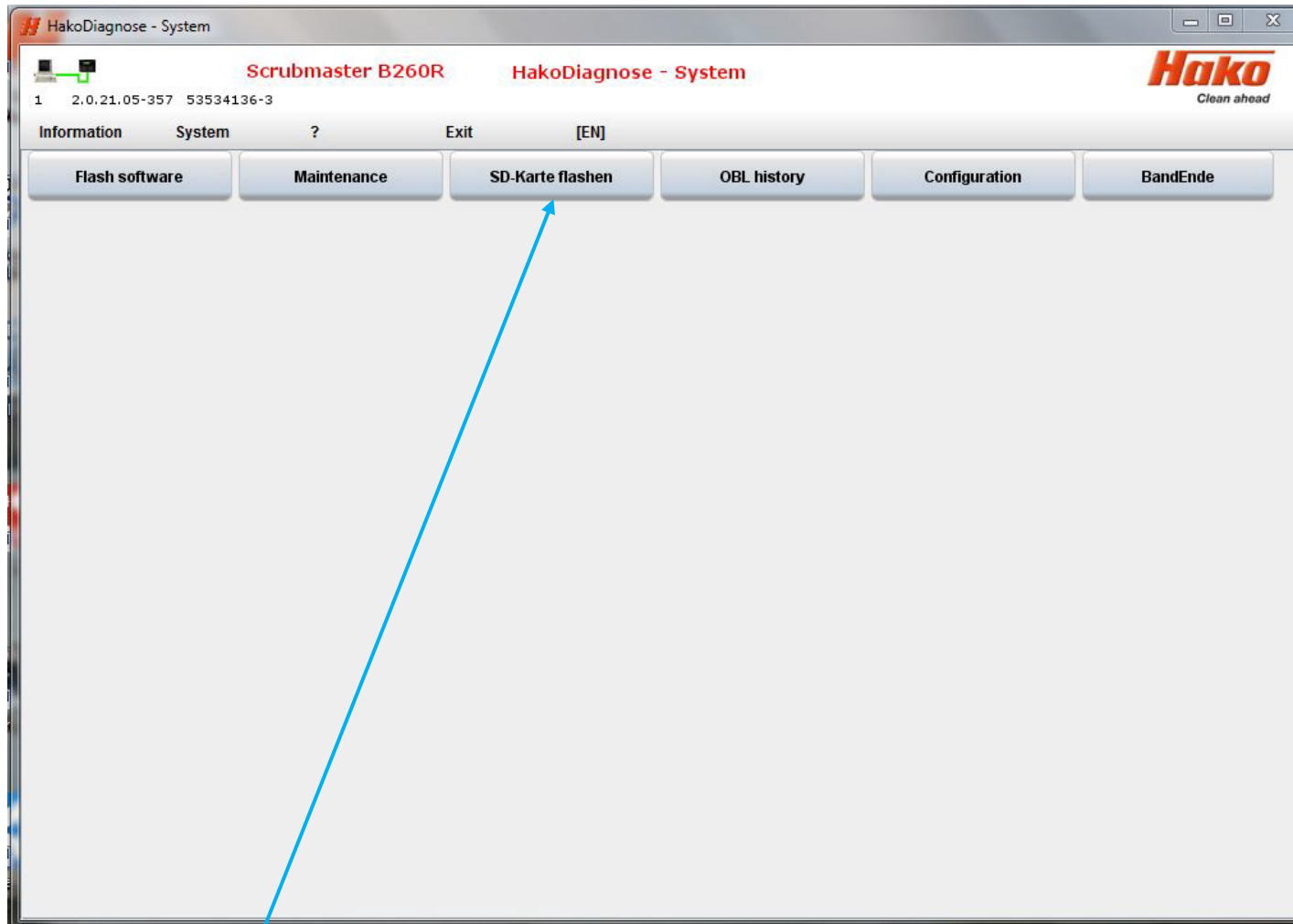

Choose the programm "SD-Karte flashen".

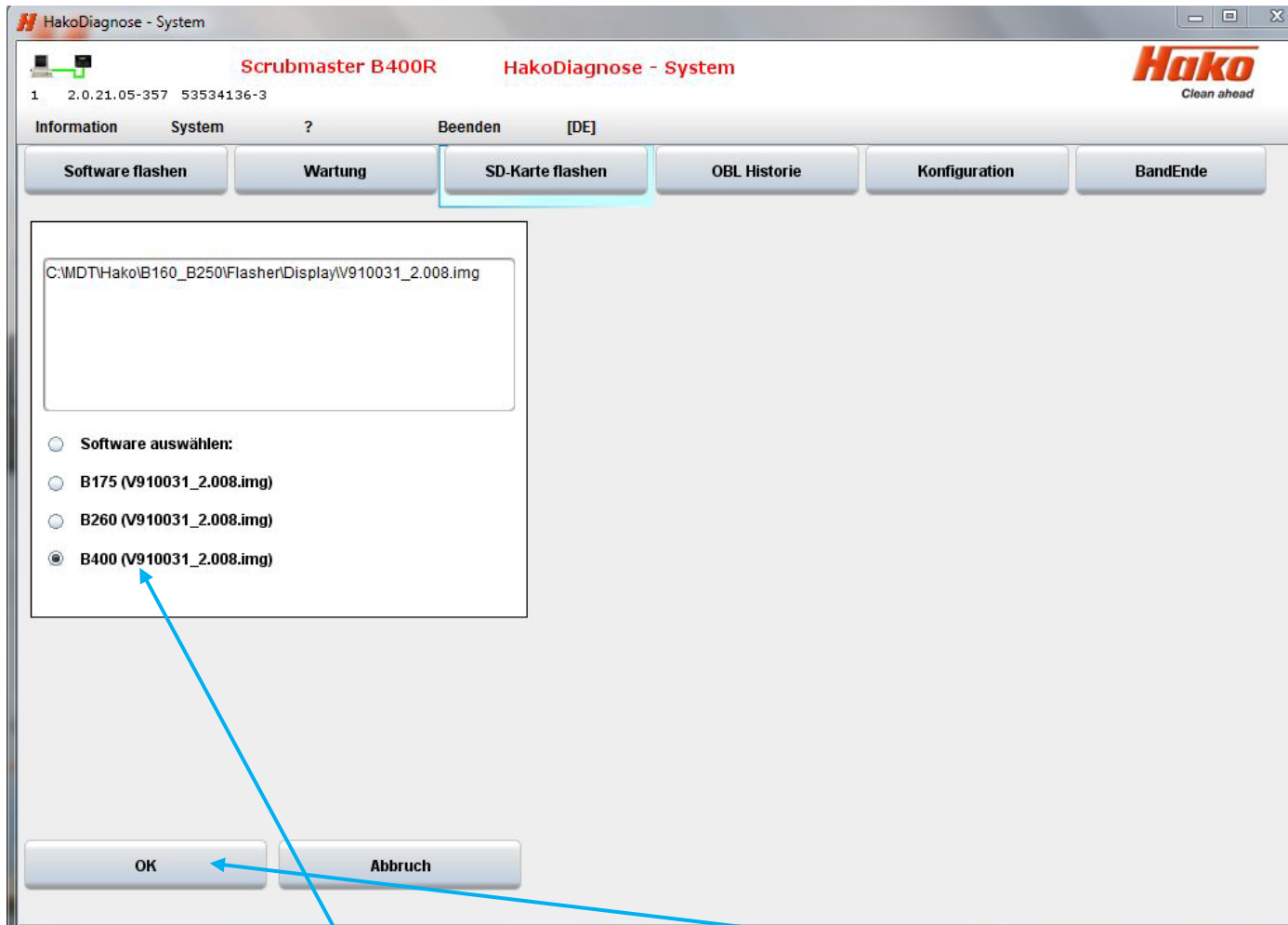

Choose corresponding machine and start flashing with "OK".

*\* The software versions shown here may differ, as the document is only a snapshot*

Possible error message with both variants

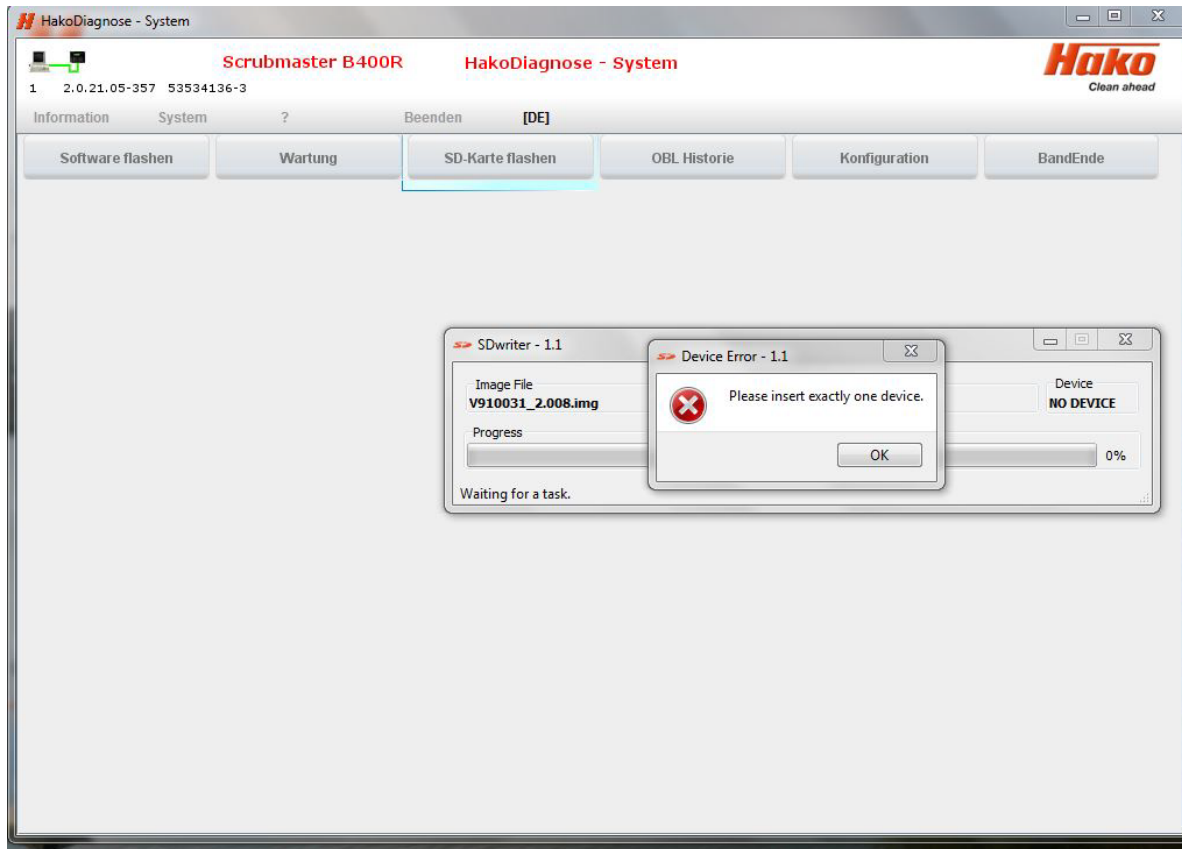

Message if there are problems with the SD card or the drive. The following errors are possible:

- SD card is defective
- SD drive is defective
- More than 1 SD drive is recognized
- Drive does not meet the specifications of the SD-Writer

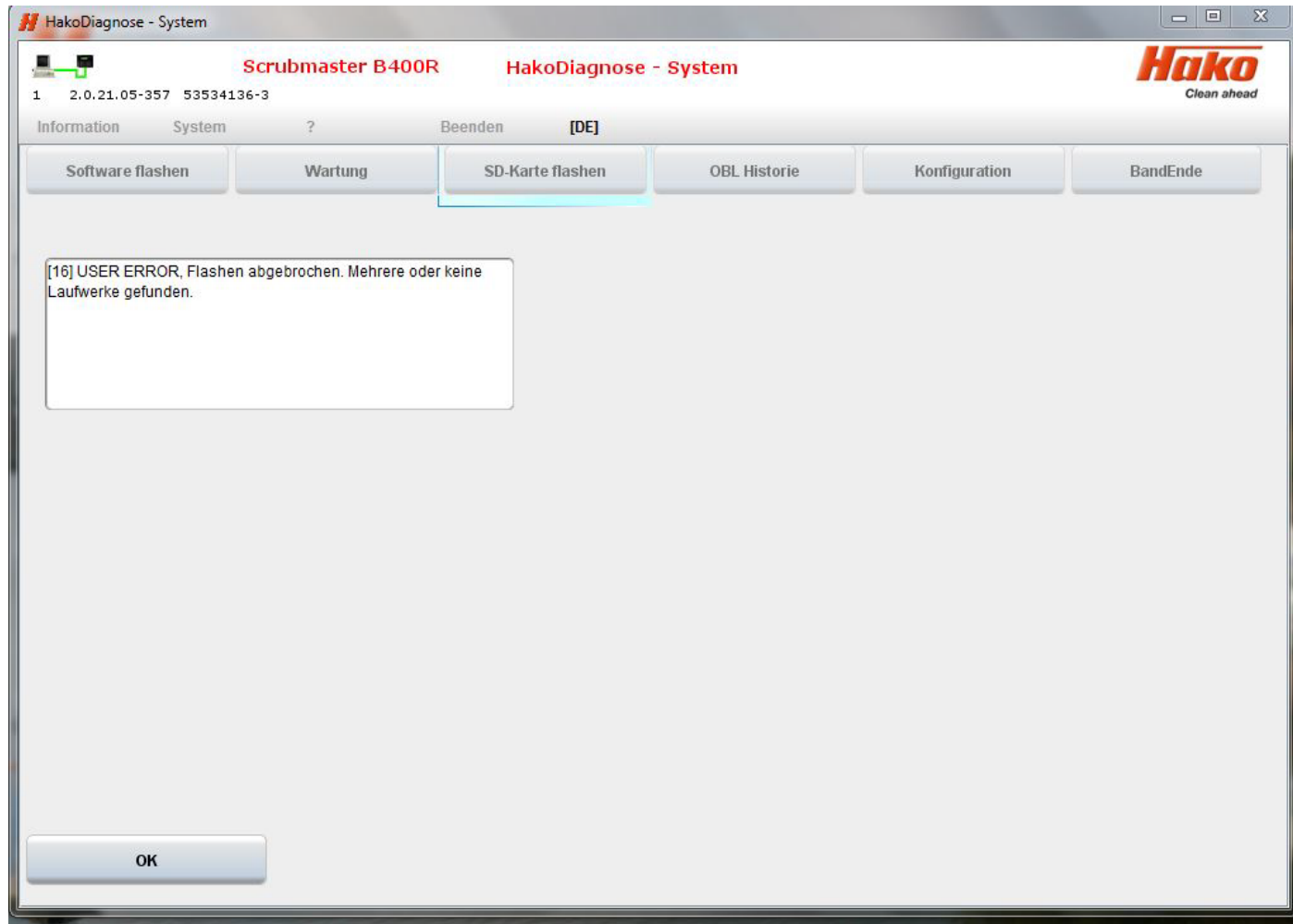

Display if the message "Please insert exactly one device" was confirmed with OK.

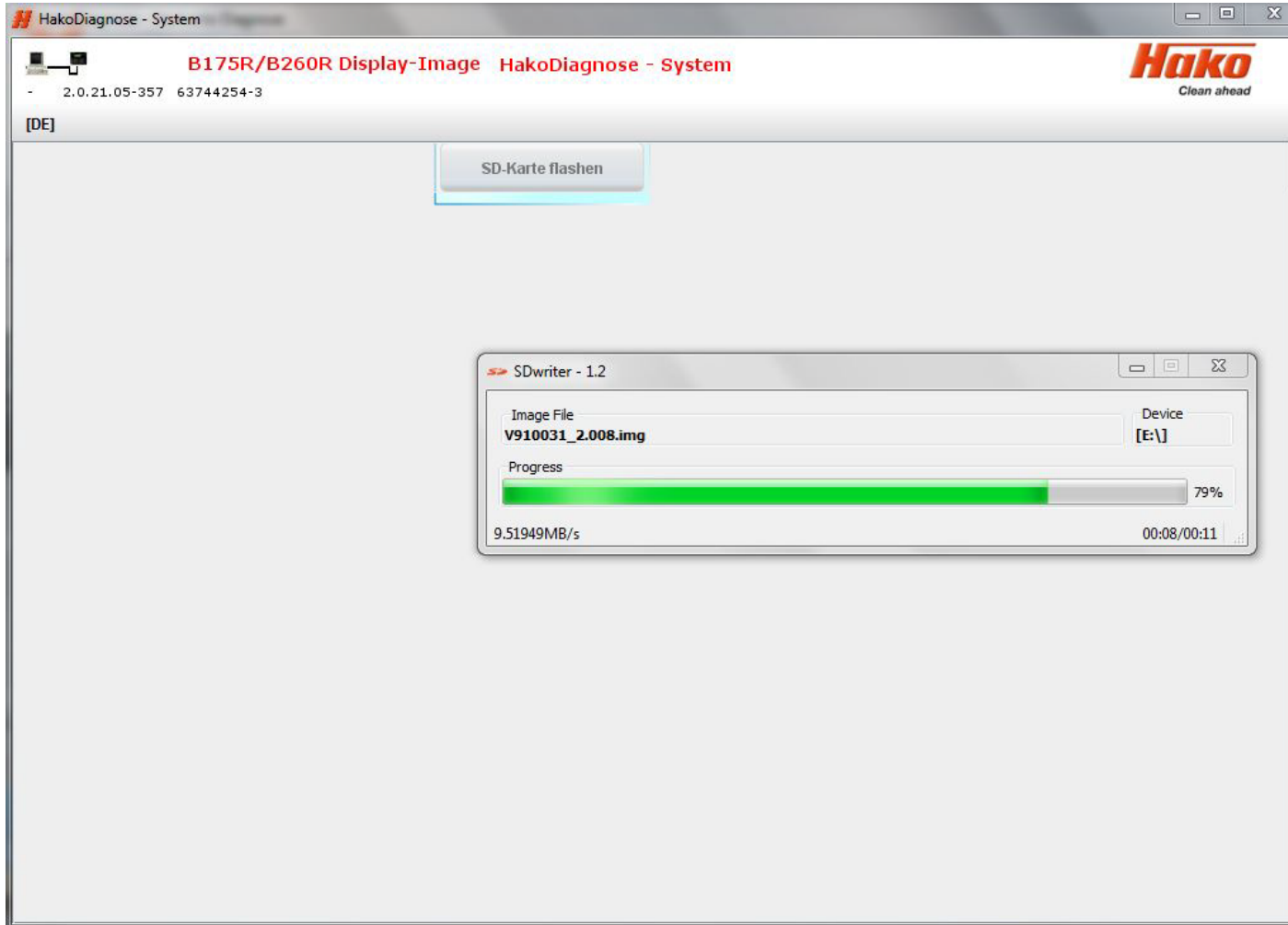

Display when the flash process has started normally

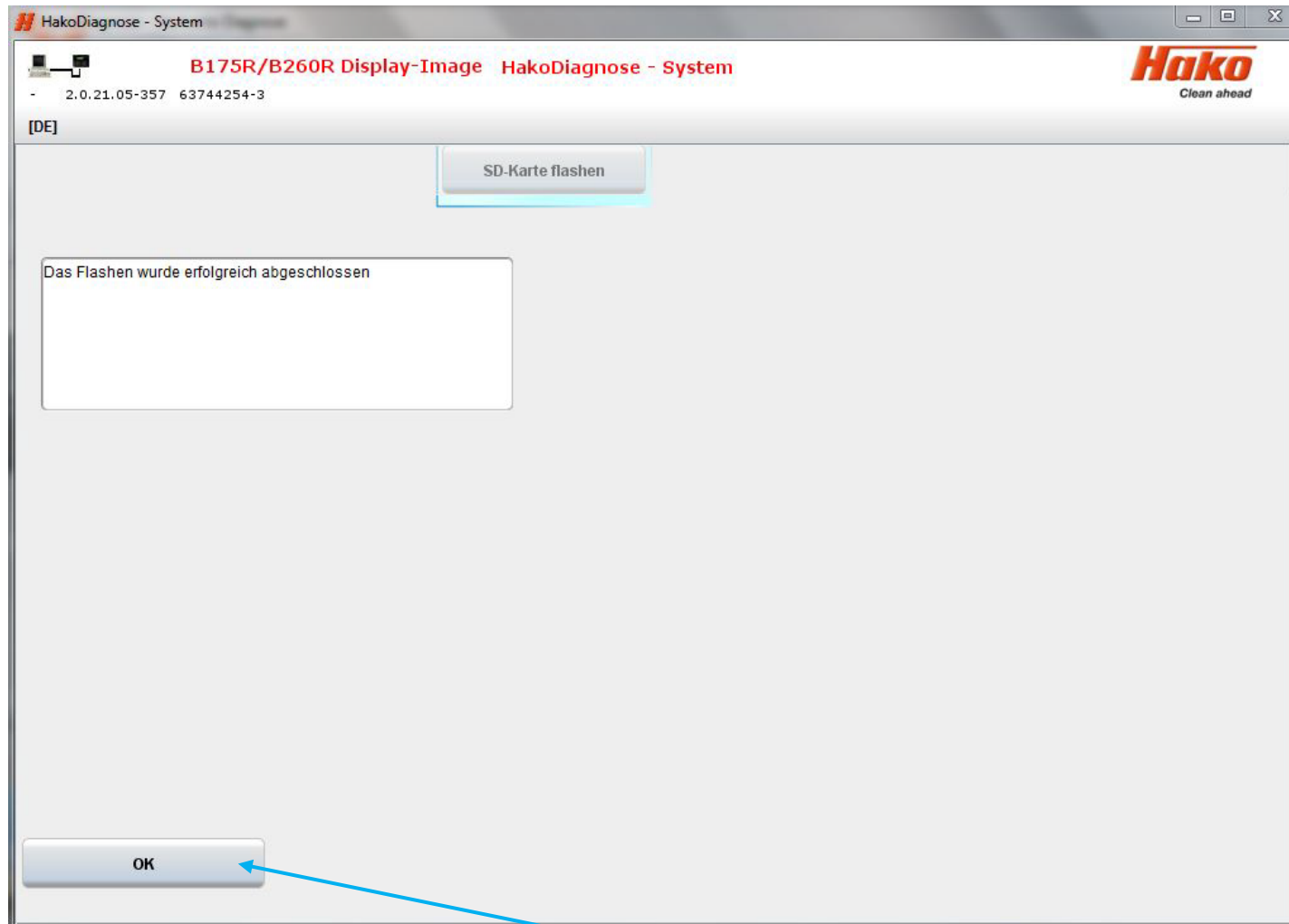

Flash process is succesfully finished. Confirm with "OK"

## SD card back into SD-Slot of display

After the flash process is done, put the SD card back (from the computer to the display).

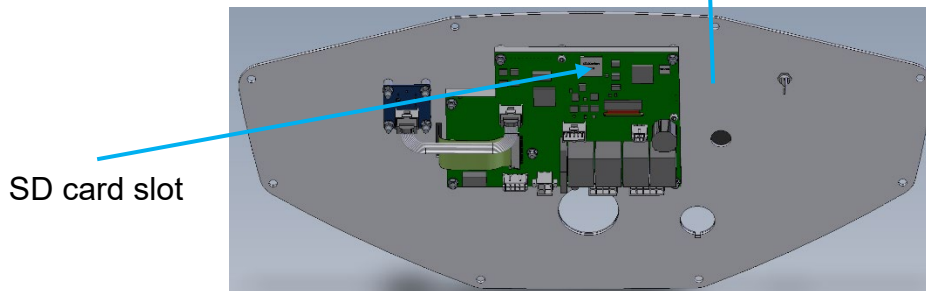
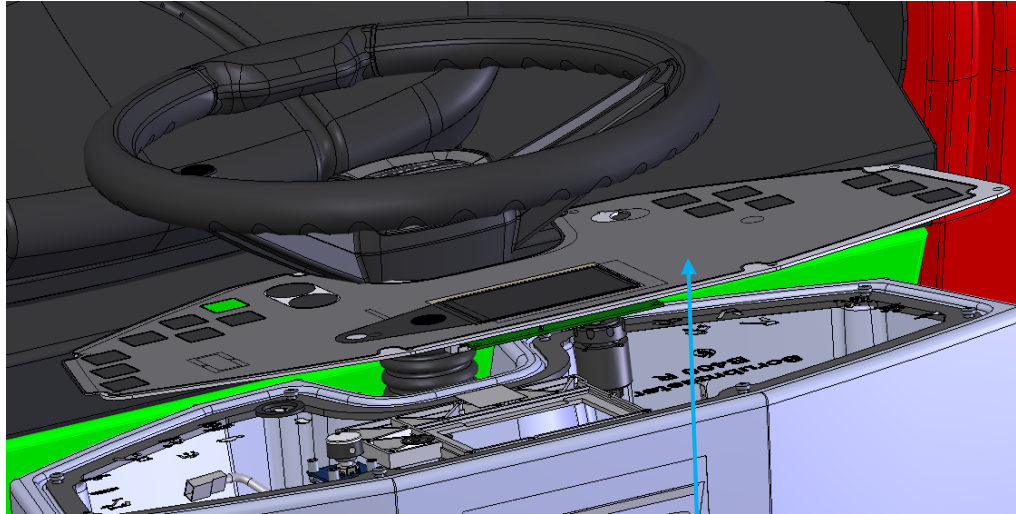

Rear side of dashboard

After the key switch is ON, the message of a new variant appears on the screen,



with the request "Update". To do this, just press the rotary push button. **Turning it leads to termination**

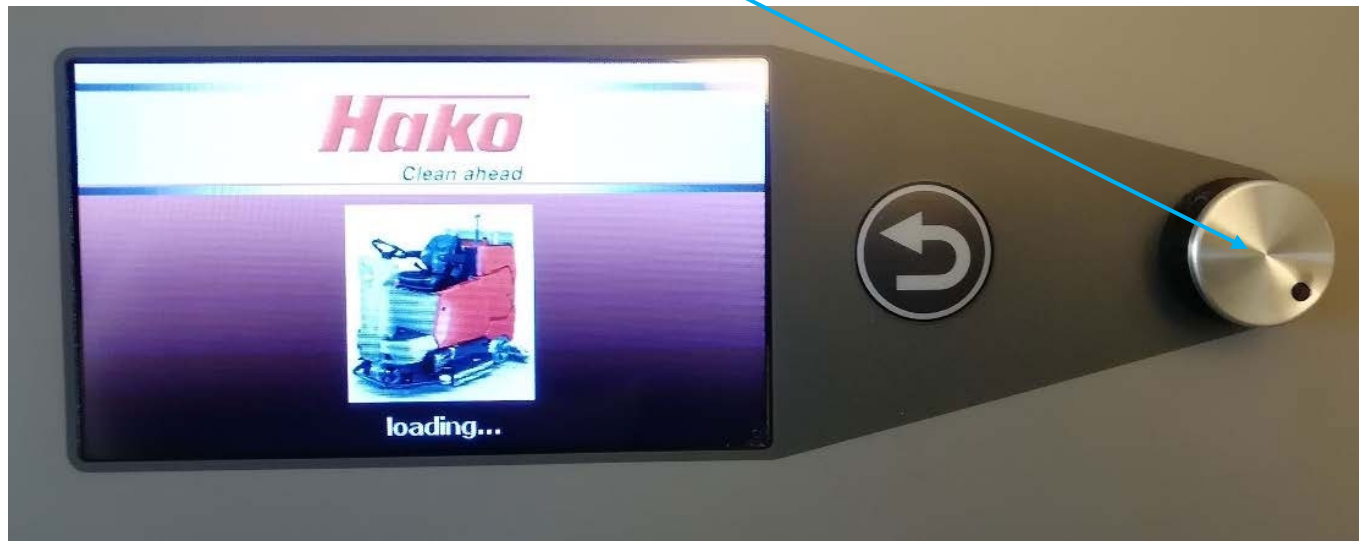



## 2) Flash software A1

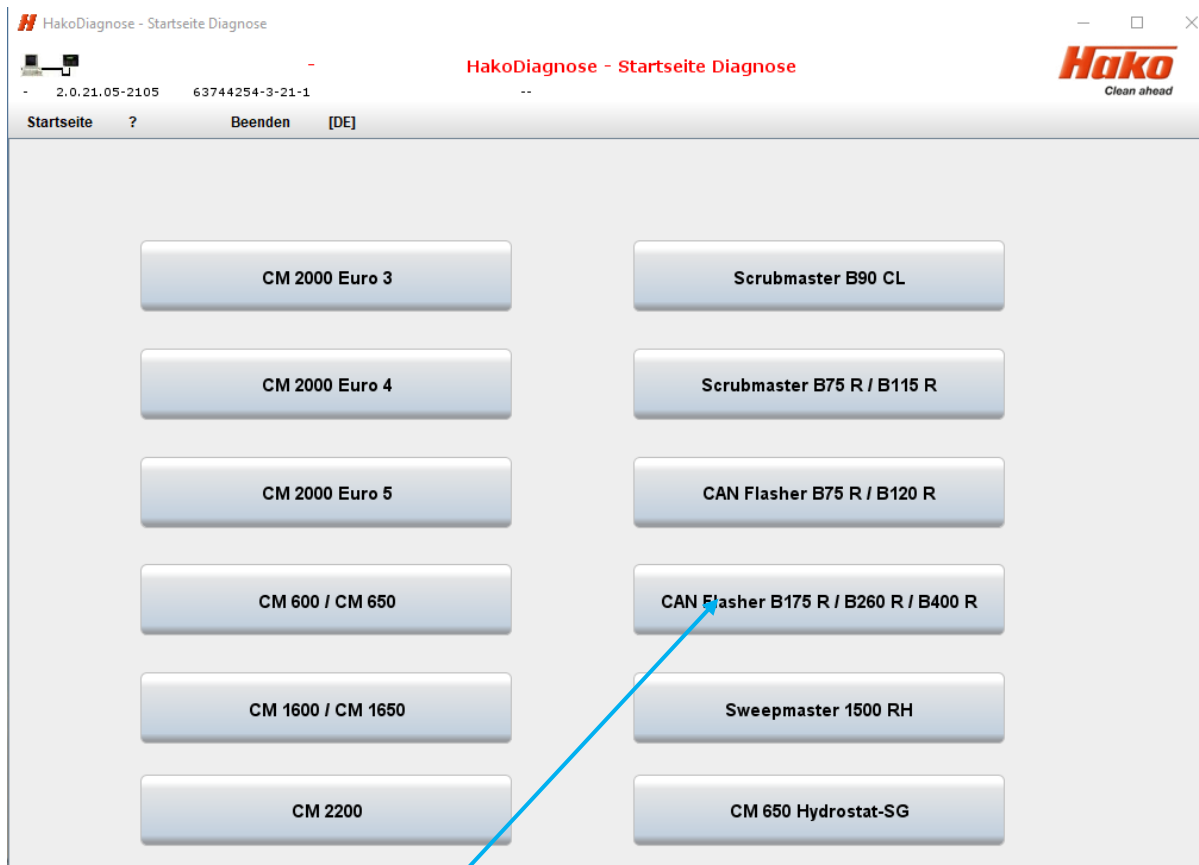

The Hako diagnosis must be connected to an interface. A connection to the machine (OBD plug) is essential.

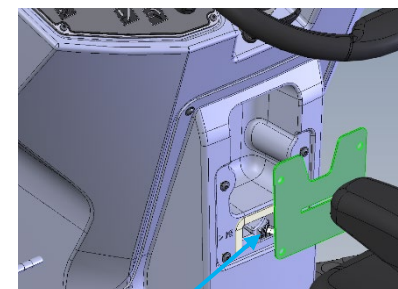

OBD plug

Choose "CAN Flasher B175R / B260R / B400R" program in Hako Diagnosis.

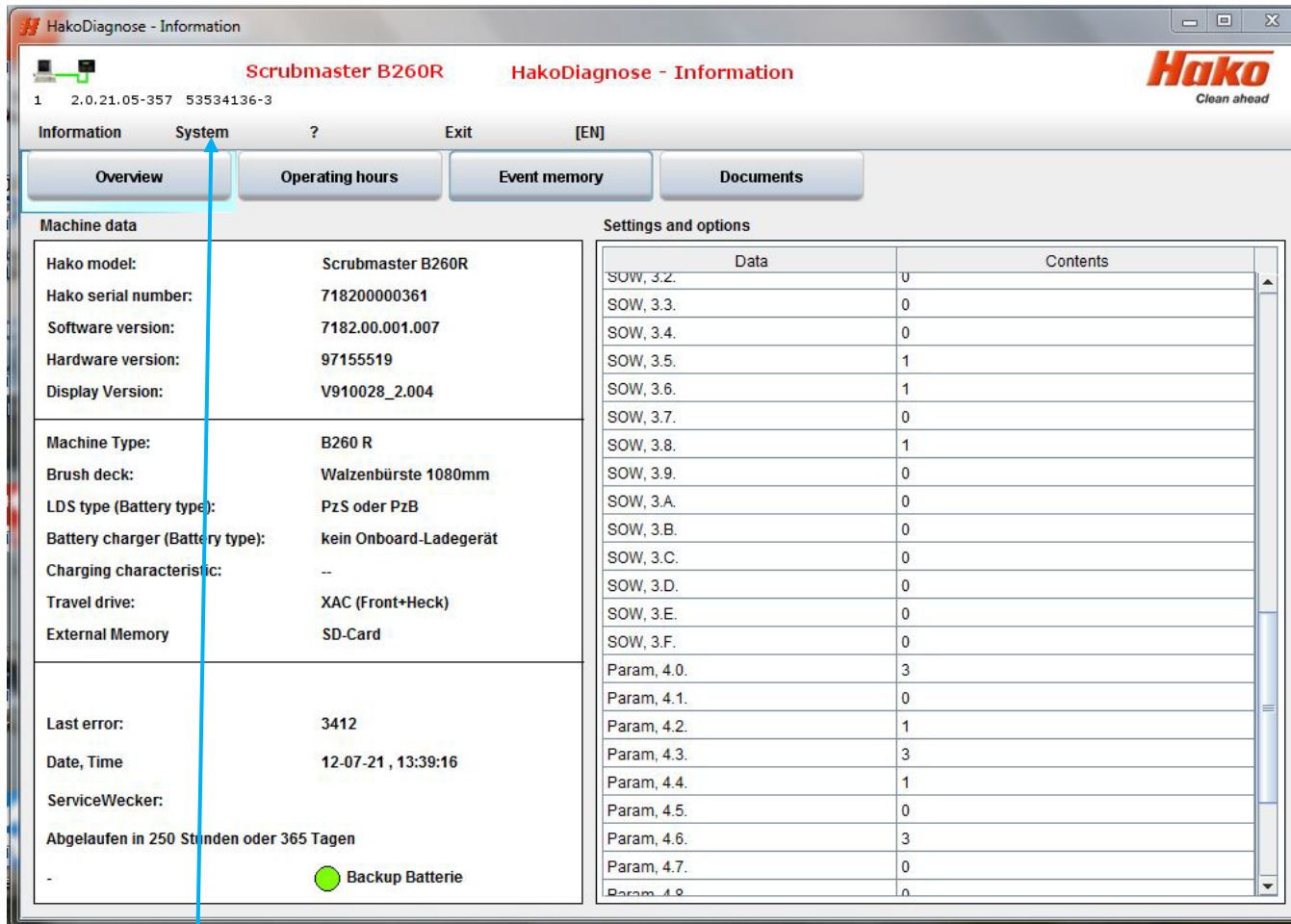

HakoDiagnose - Information

Scrubmaster B260R HakoDiagnose - Information

1 2.0.21.05-357 53534136-3

Information System ? Exit [EN]

Overview Operating hours Event memory Documents

**Machine data**

Hako model:	Scrubmaster B260R
Hako serial number:	718200000361
Software version:	7182.00.001.007
Hardware version:	97155519
Display Version:	V910028_2.004
Machine Type:	B260 R
Brush deck:	Walzenbürste 1080mm
LDS type (Battery type):	PzS oder PzB
Battery charger (Battery type):	kein Onboard-Ladegerät
Charging characteristic:	--
Travel drive:	XAC (Front+Heck)
External Memory	SD-Card
Last error:	3412
Date, Time	12-07-21 , 13:39:16
ServiceWecker:	
Abgelaufen in 250 Stunden oder 365 Tagen	
-	 Backup Batterie

**Settings and options**

Data	Contents
SOW, 3.Z.	0
SOW, 3.3.	0
SOW, 3.4.	0
SOW, 3.5.	1
SOW, 3.6.	1
SOW, 3.7.	0
SOW, 3.8.	1
SOW, 3.9.	0
SOW, 3.A.	0
SOW, 3.B.	0
SOW, 3.C.	0
SOW, 3.D.	0
SOW, 3.E.	0
SOW, 3.F.	0
Param, 4.0.	3
Param, 4.1.	0
Param, 4.2.	1
Param, 4.3.	3
Param, 4.4.	1
Param, 4.5.	0
Param, 4.6.	3
Param, 4.7.	0
Param, 4.8.	0

Choose menu "System" (sample B260R, equal for all types).

\* The software versions shown here may differ, as the document is only a snapshot

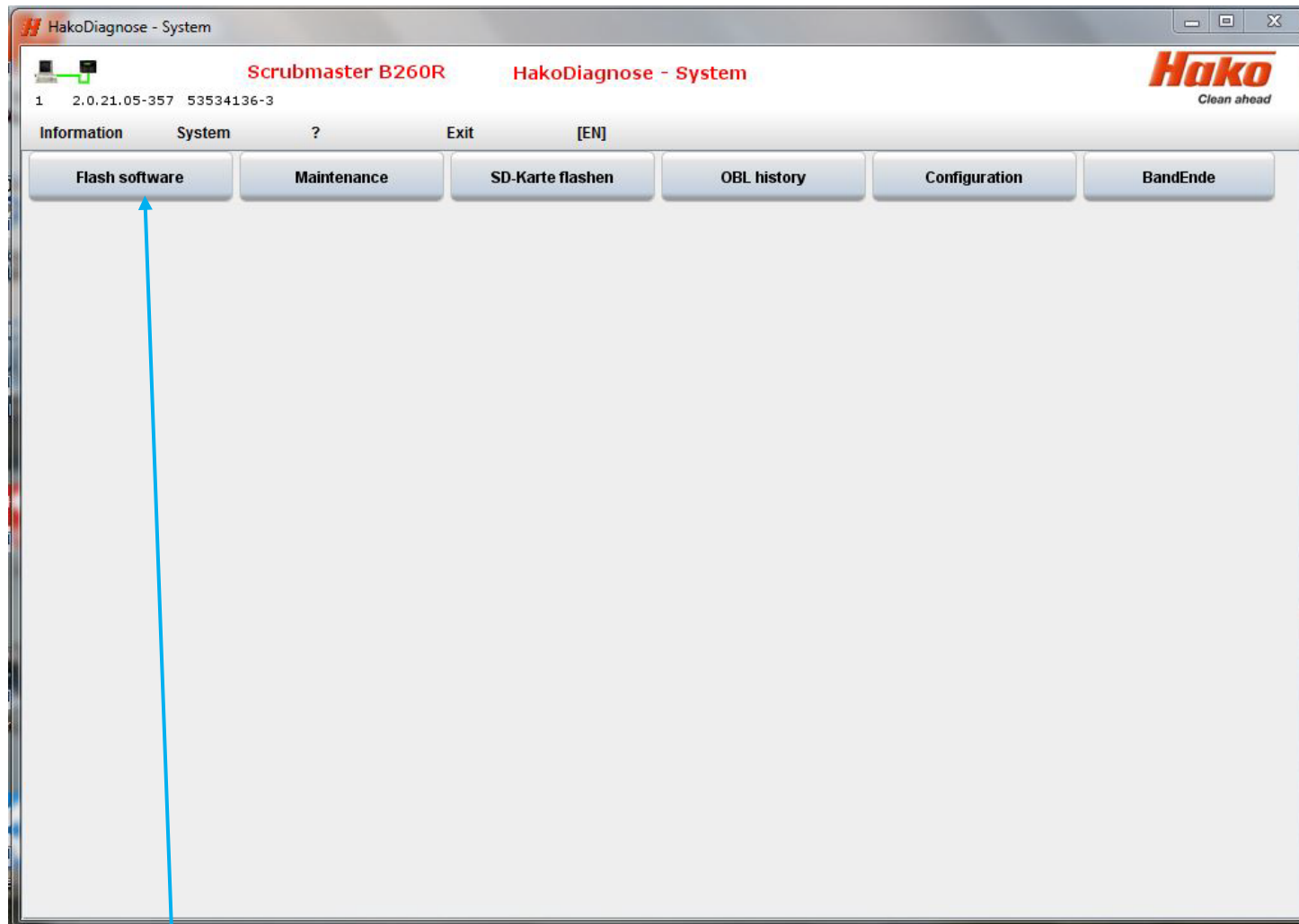

Choose program "Flash software".

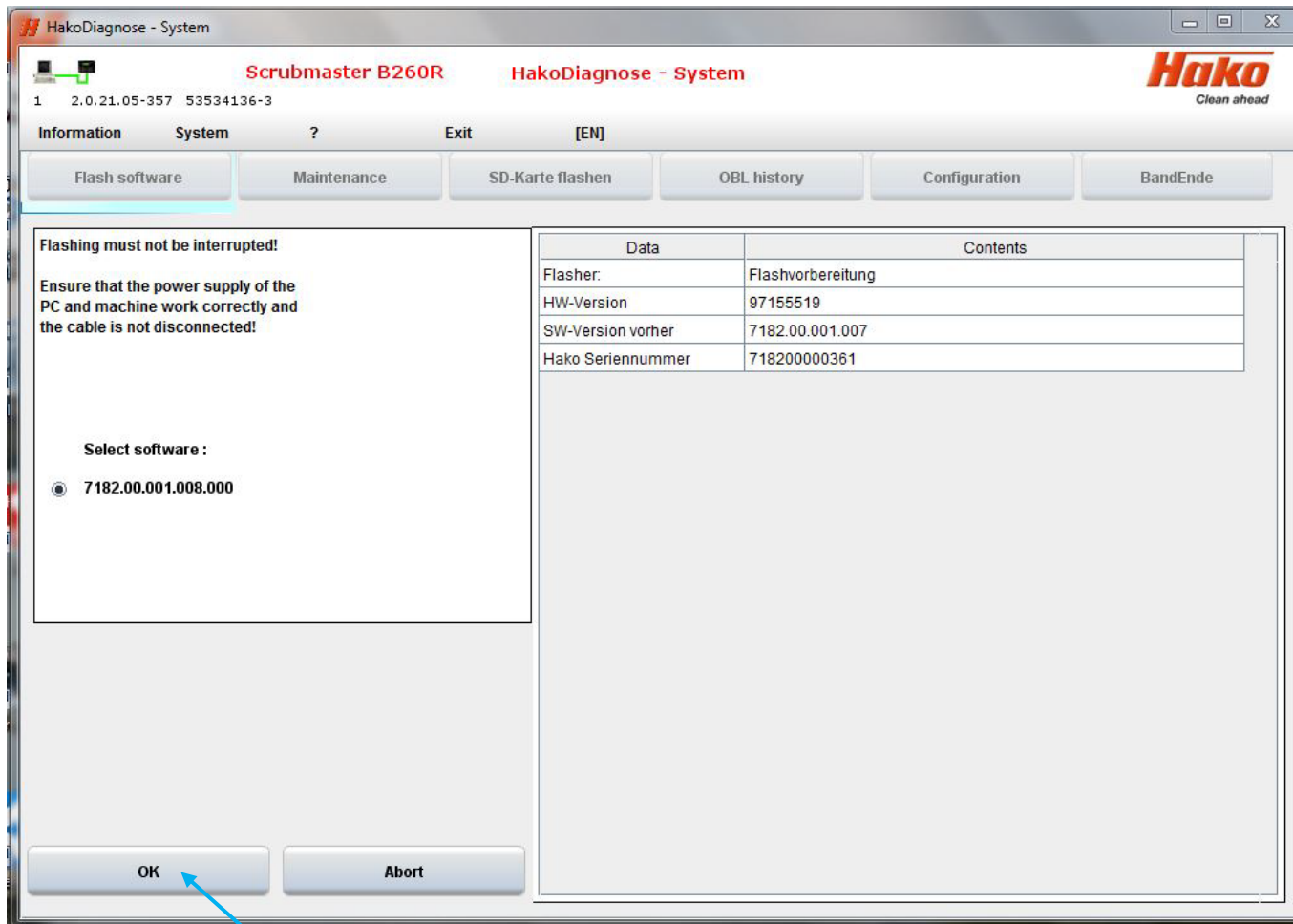

Start flash process with "OK".

*\* The software versions shown here may differ, as the document is only a snapshot*

HakoDiagnose - System

Scrubmaster B260R HakoDiagnose - System

2.0.21.05-357 53534136-3

Information System ? Beenden [DE]

Software flashen **Wartung** SD-Karte flashen OBL Historie Konfiguration BandEnde

**Das Flashen darf nicht unterbrochen werden!**

Sicherstellen, das die Spannungsversorgung von PC und Maschine korrekt arbeitet und die Kabelverbindung nicht unterbrochen wird!

Software auswählen:

7182.00.001.008.000

Daten	Inhalt
Flasher:	Flashvorbereitung
HW-Version	97155519
SW-Version vorher	7182.00.001.007
Hako Seriennummer	718200000361
	008.000.hex
	STATUS_LOAD_FILE
	STATUS_CONNECT_J2534
	STATUS_CHECK_STATE
	STATUS_READ_ECU_ID
	STATUS_SEND_PASSWORD
	STATUS_ERASE_FLASH
Flasher:	\$ACTION_STATUS_FLASH_PROGRESS
Flasher:	\$ACTION_STATUS_CHECK_FW
Flasher:	\$ACTION_STATUS_SWITCH_TO_APP
Flasher:	\$ACTION_STATUS_OK
Flasher:	Erfolg

**Das Flashen war erfolgreich!**  
Bitte den Schlüsselschalter aus- und einschalten, dann bestätigen.

OK

Flash process is succesfully finished. Confirm with "OK"

If only update software A1 is carried out. The following display appear after the key switch is ON.  
This means that newer display software is required

needed display  
software

existing display  
software



*\* The software versions shown here may differ, as the document is only a snapshot*

### 3) Check software versions

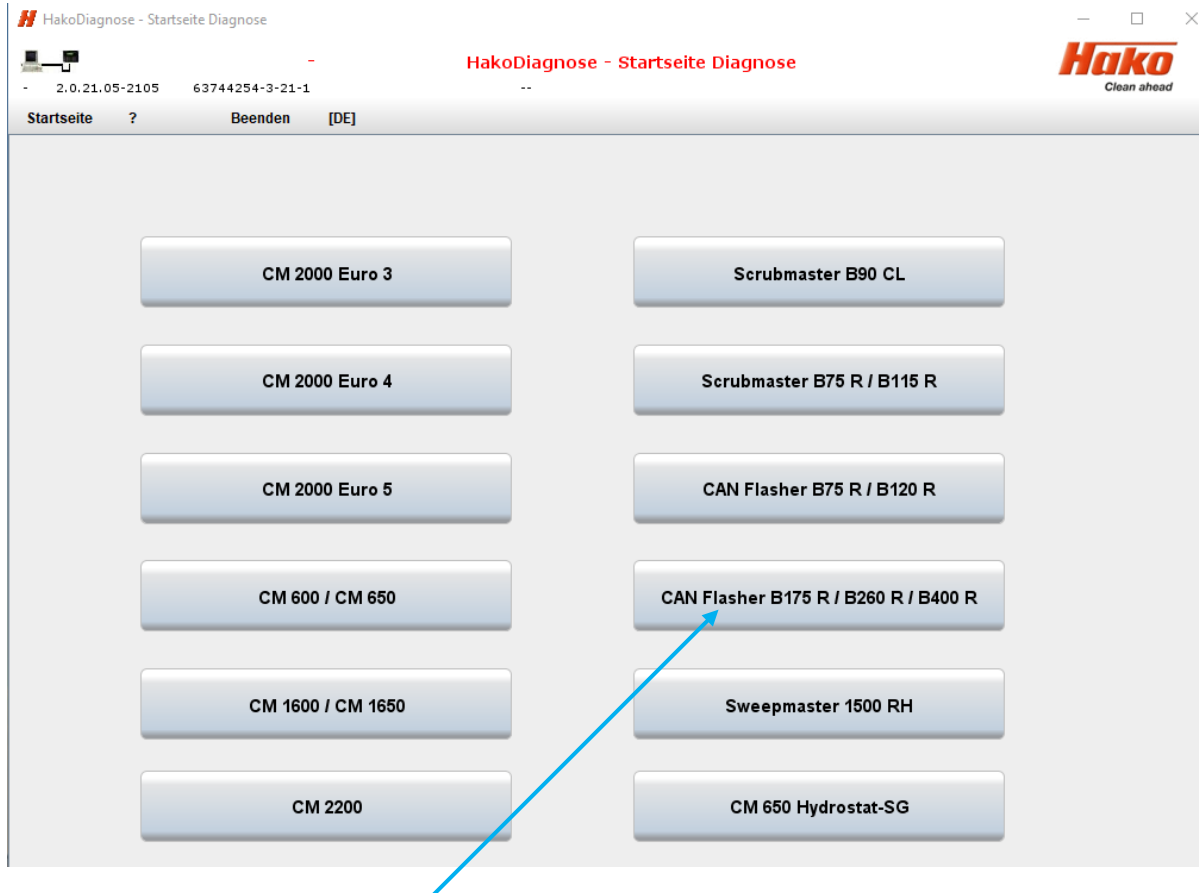

Choose "CAN Flasher B175R / B260R / B400R" program in Hako Diagnosis.



HakoDiagnose - Information

Scrubmaster B260R HakoDiagnose - Information

1 2.0.21.05-357 53534136-3

Information System ? Exit [EN]

Overview Operating hours Event memory Documents

**Machine data**

Hako model: Scrubmaster B260R

Hako serial number: 718200000361

Software version: 7182.00.001.008.000

Hardware version: 97155519

Display Version: V910031\_2.008

---

Machine Type: B260 R

Brush deck: Walzenbürste 1080mm

LDS type (Battery type): PzS oder PzB

Battery charger (Battery type): kein Onboard-Ladegerät

Charging characteristic: --

Travel drive: XAC (Front+Heck)

External Memory: SD-Card

---

Last error: 4535

Date, Time: 12-07-21 , 14:24:04

ServiceWecker:

Abgelaufen in 250 Stunden oder 365 Tagen

-  Backup Batterie

**Settings and options**

Data	Contents
SOW, 3.2.	0
SOW, 3.3.	0
SOW, 3.4.	0
SOW, 3.5.	1
SOW, 3.6.	1
SOW, 3.7.	0
SOW, 3.8.	1
SOW, 3.9.	0
SOW, 3.A.	0
SOW, 3.B.	0
SOW, 3.C.	0
SOW, 3.D.	0
SOW, 3.E.	0
SOW, 3.F.	0
Param, 4.0.	3
Param, 4.1.	0
Param, 4.2.	1
Param, 4.3.	3
Param, 4.4.	1
Param, 4.5.	0
Param, 4.6.	3
Param, 4.7.	0
Param, 4.8.	1

Compare the version numbers under "" Display Version: and Software Version: "with the specification (sample B260R, equal for all types)

\* The software versions shown here may differ, as the document is only a snapshot



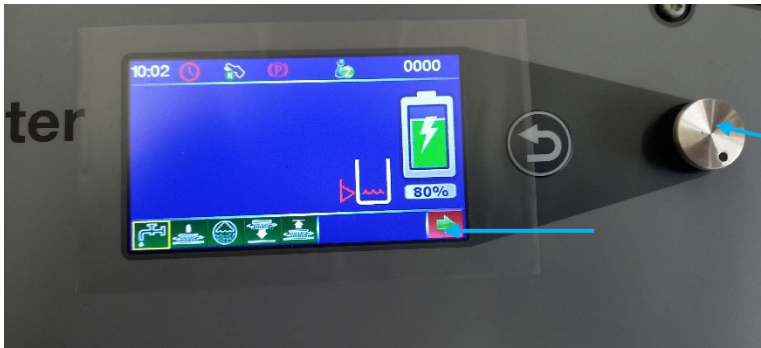

**Alternative method** to check versions (sample B260R, equal for all types)

"Rotate" until green arrow on red background confirm by "Pressing" rotary push button



"Rotate" until the information field is framed in yellow confirm by "Pressing" rotary push button



*(sample B260R, equal for all types)*

- Serial number of the machine
- Display version
- Front wheel drive control version
- Rear wheels drive control version
- Main board (A1) version
- Bootloader version